

be pe ep
a

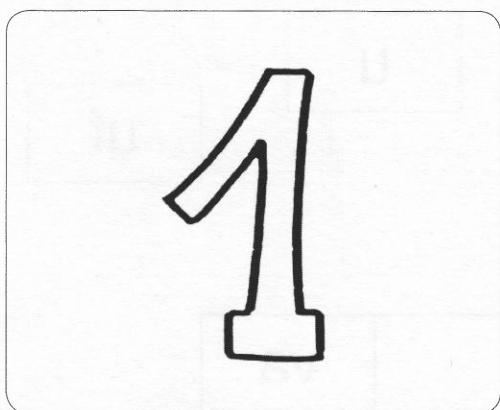

un nu u
no

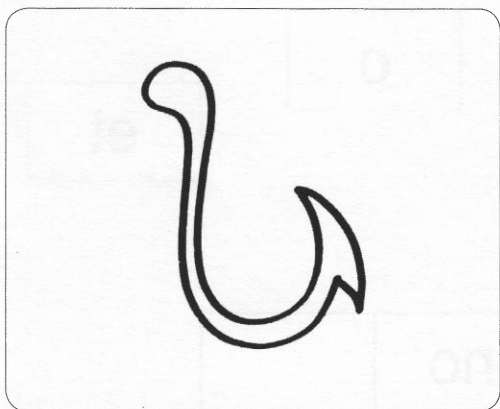

am mo o
a

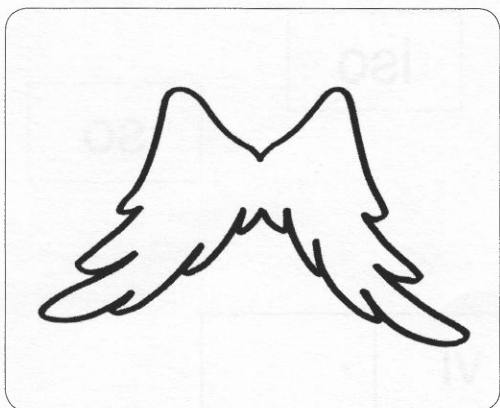

a al i
li

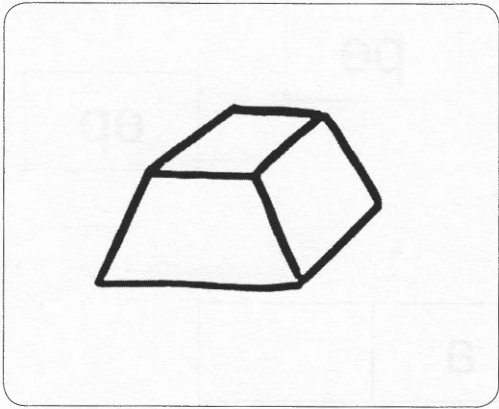

po or ro

o

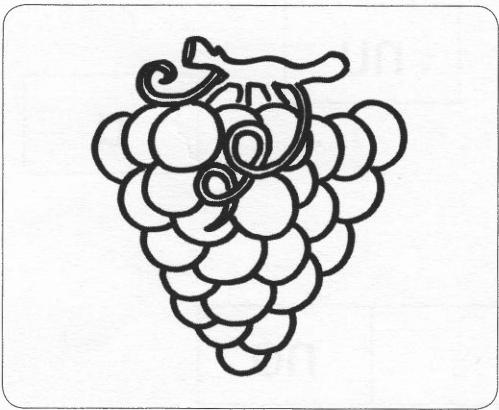

uv u uf

va

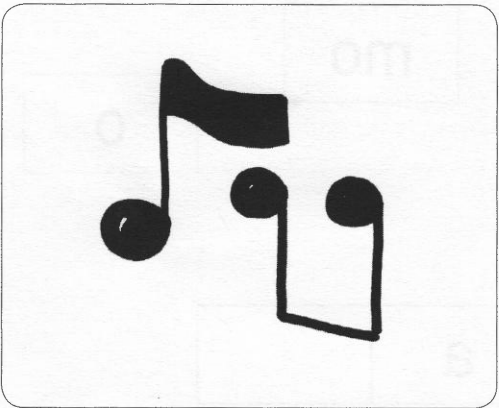

te o et

no

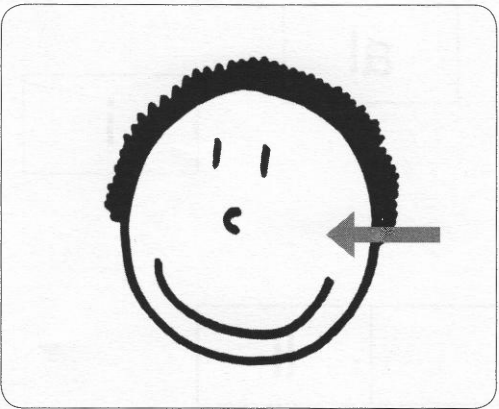

zo iso so

vi

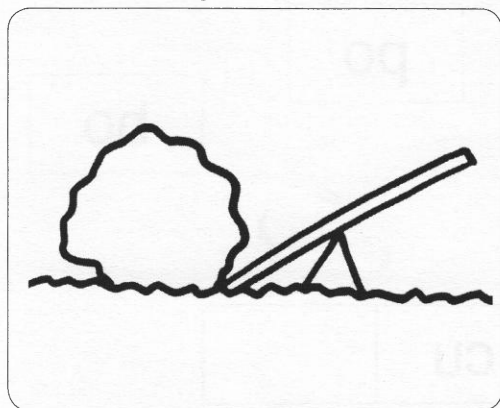

le

ev

l

va

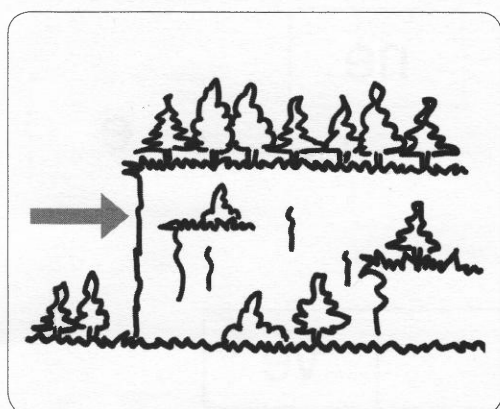

u

ru

rp

pe

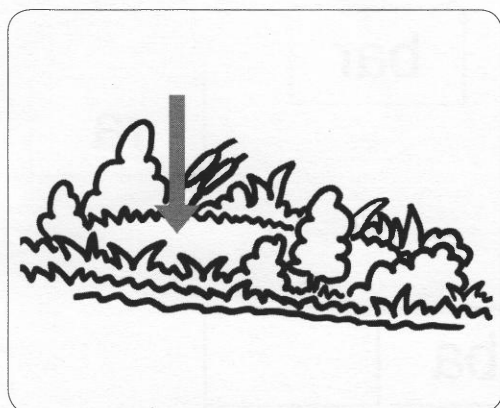

al

lag

la

go

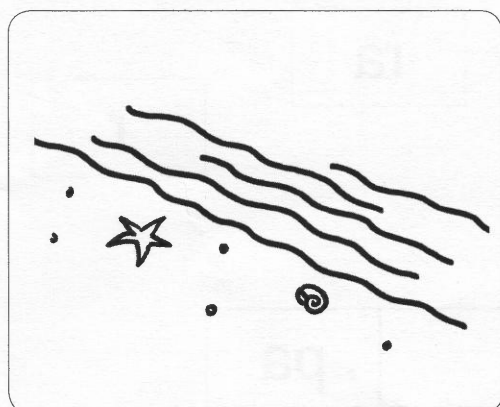

va

fa

ra

ri

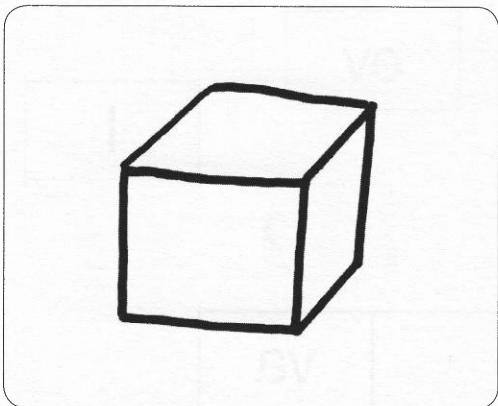

o

po

bo

cu

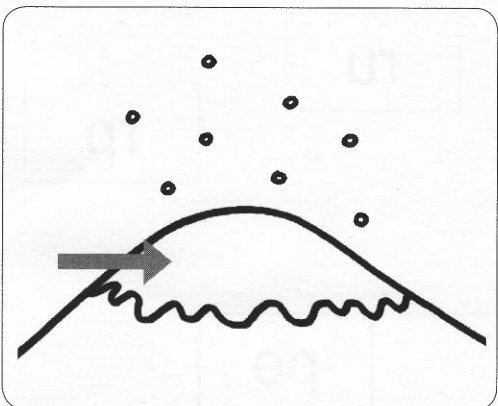

ev

ne

e

ve

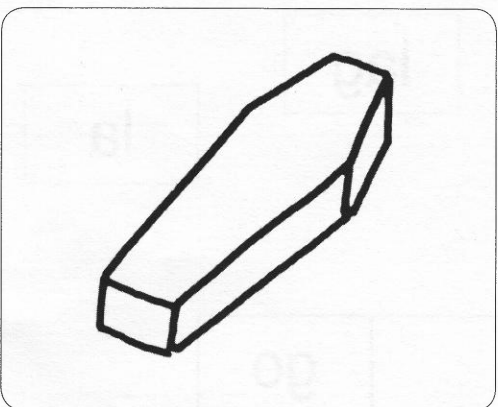

pa

bar

ra

ba

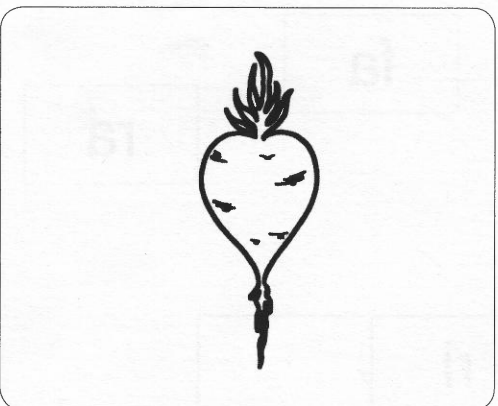

rap

ra

r

pa

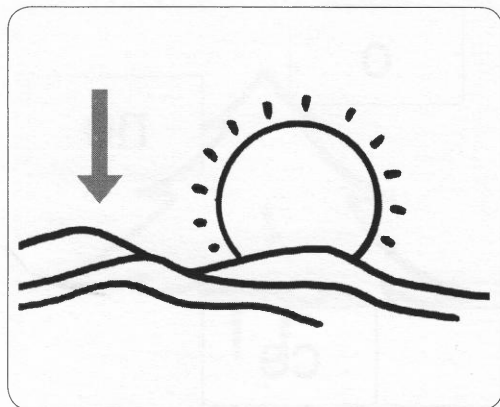

n an na
du

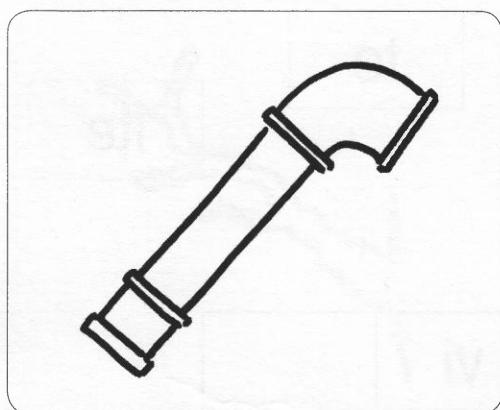

tu tub u
bo

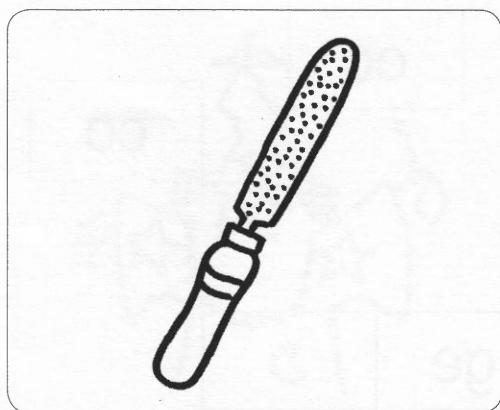

il na ma
li

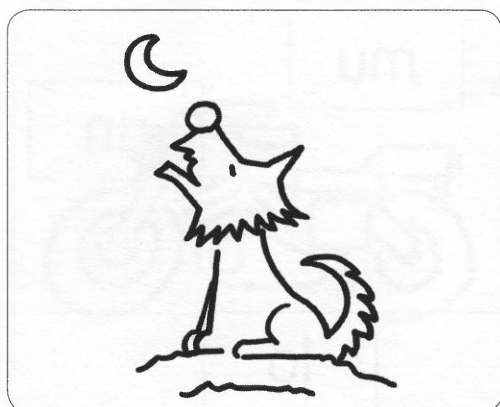

op o po
lu

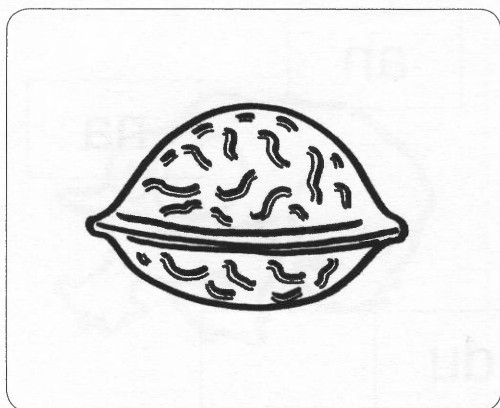

on o no

ce

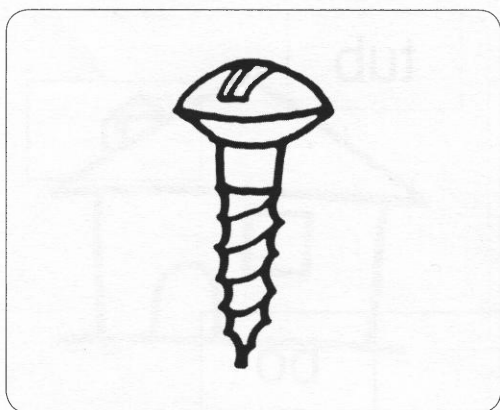

et te ite

vi



ec oc co

ge

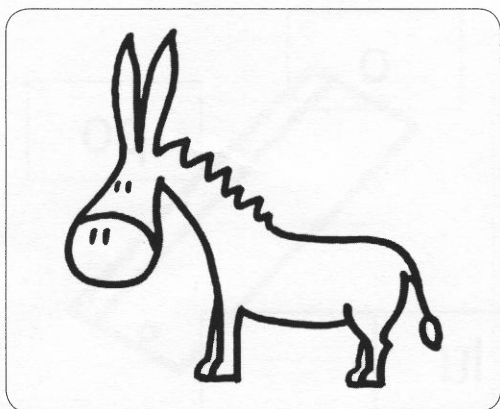

lo mu un

lo

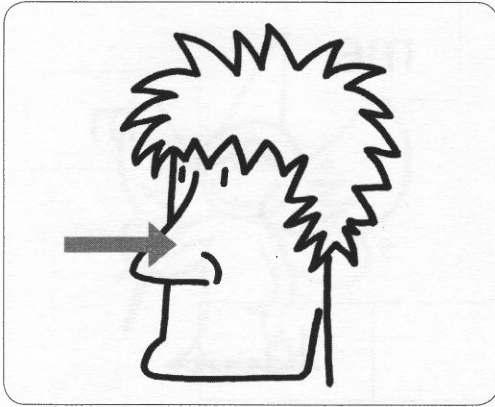

na aso nas

so

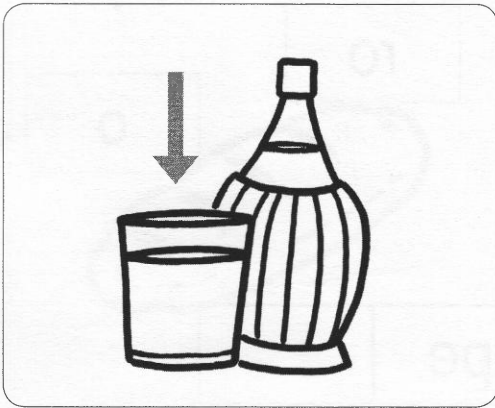

vin ni vi

no

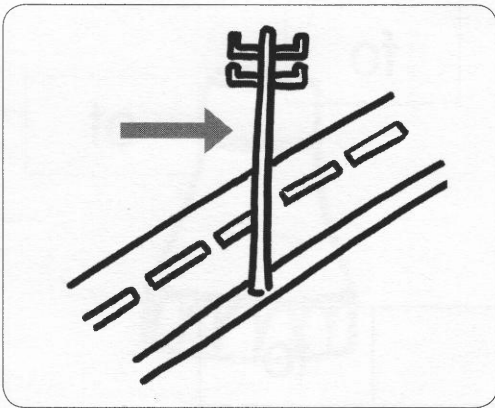

alo ao lo

pa

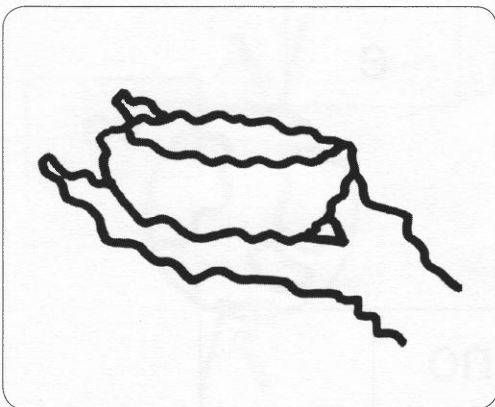

no ido do

ni

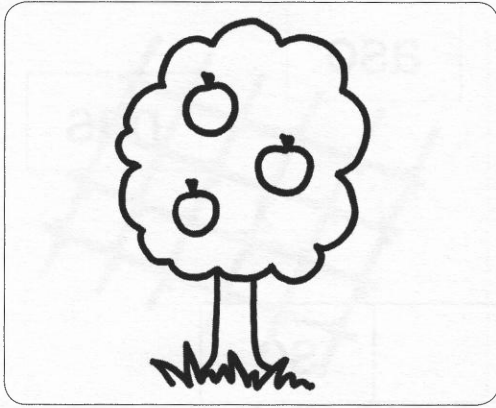

mel

me

m

lo

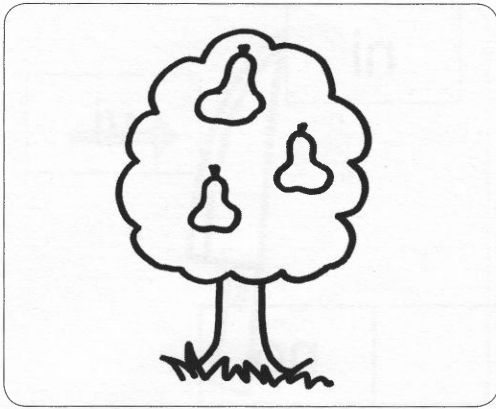

ero

ro

o

pe

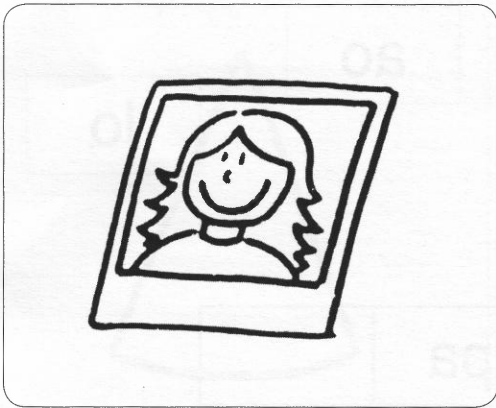

ot

fo

of

to

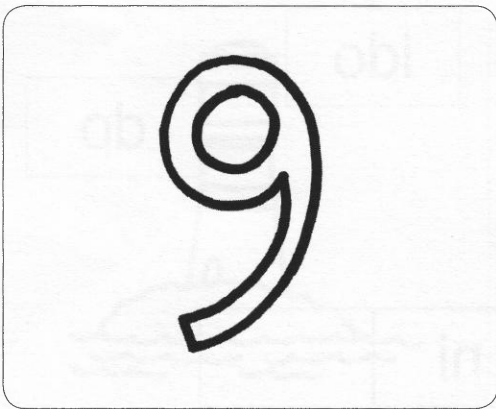

ove

e

ve

no

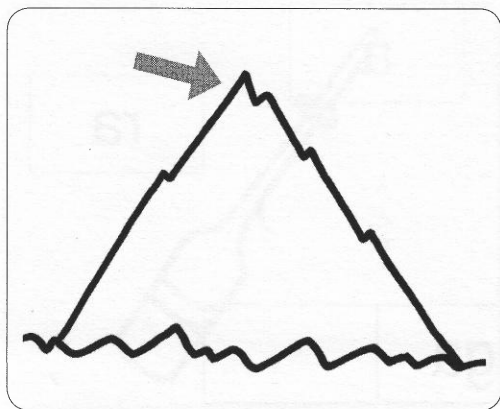

a ma am
ci

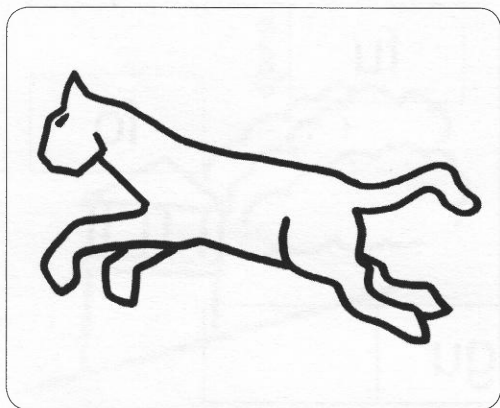

ua a ma
pu

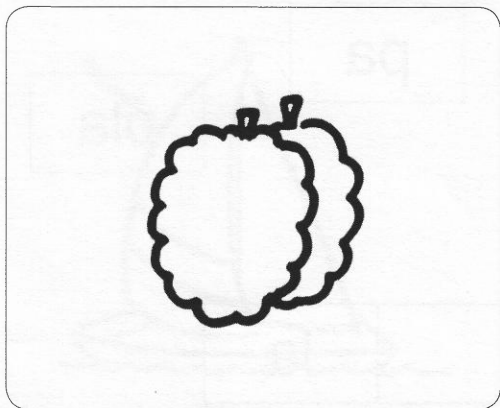

mo or om
re

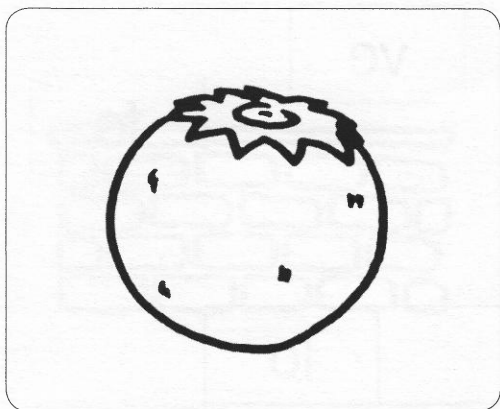

o po mo
mo

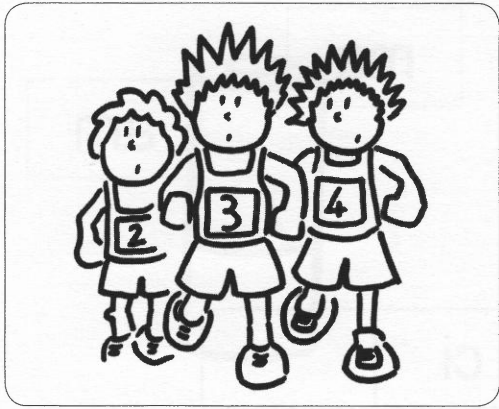

ca a ra

ga

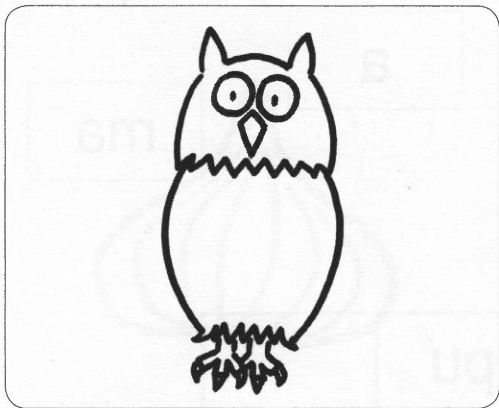

o fu fo

gu

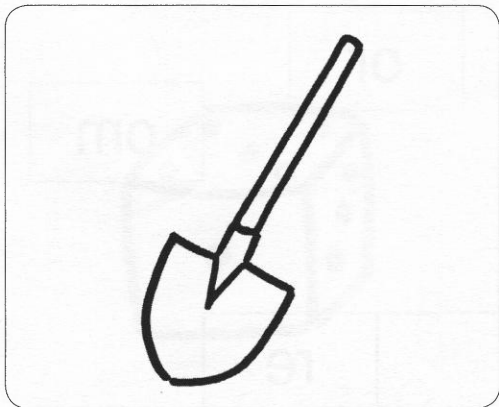

da pa pla

 la

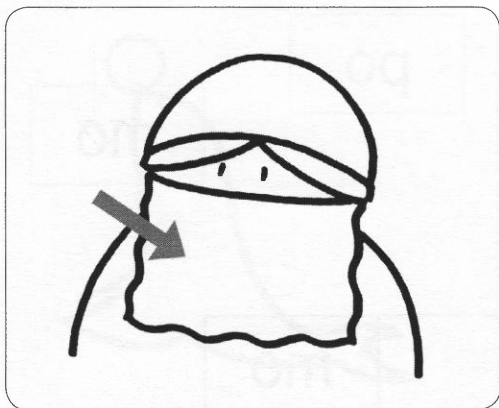

le ve fe

 lo

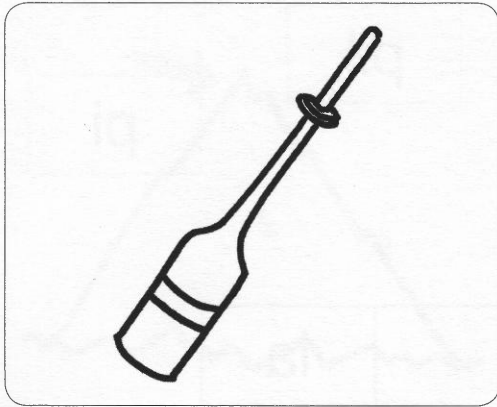

om mor mo

re

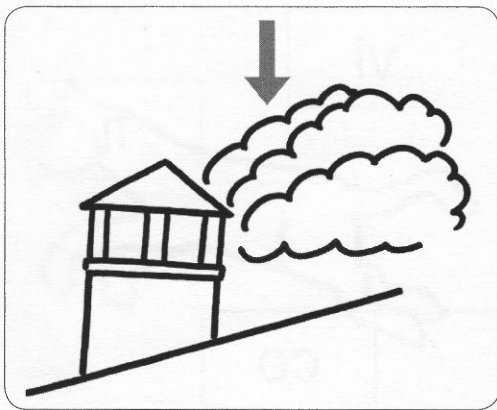

mo umo mu

fu

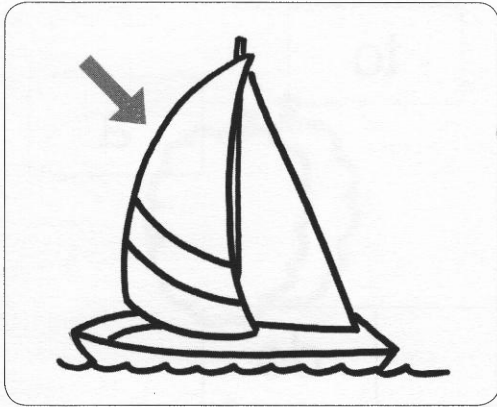

ela la al

ve

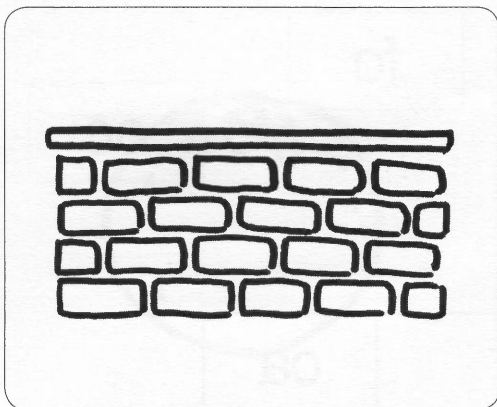

ro uro o

mu

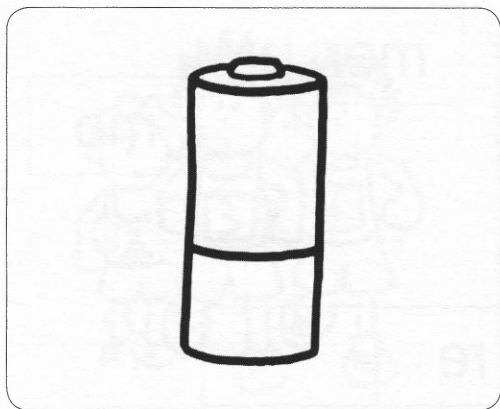

i pil pi

 la

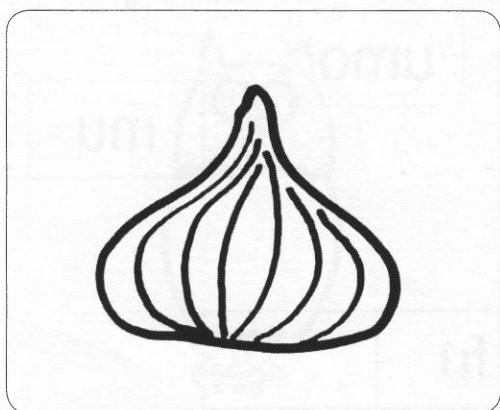

ci vi fi

 co

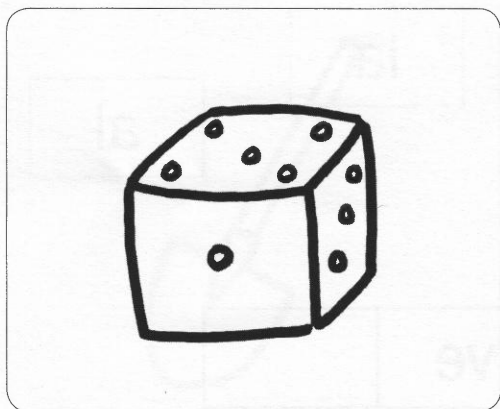

da to a

 do

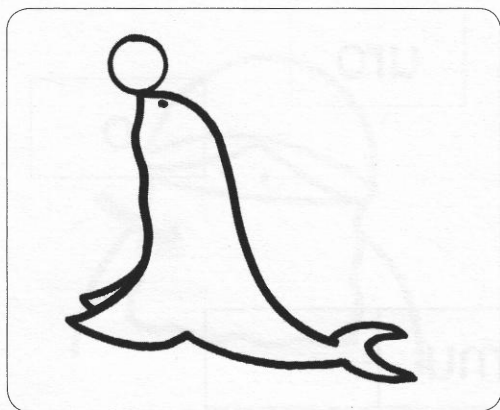

foc fo oc

 ca



ata
at ta
fa

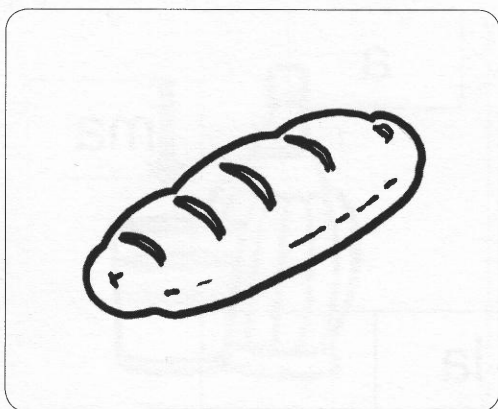

an
pa ap
ne

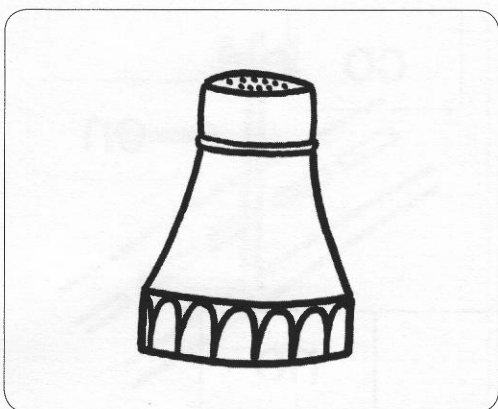

le
sal se
sa

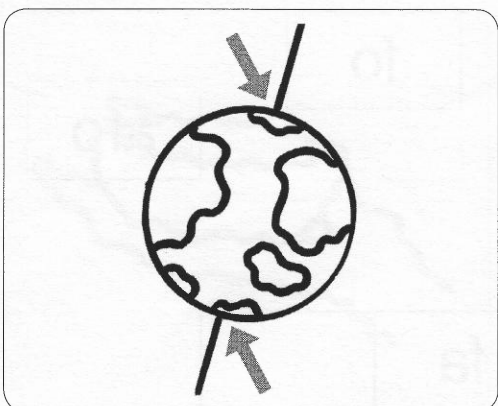

po
pol pi
li

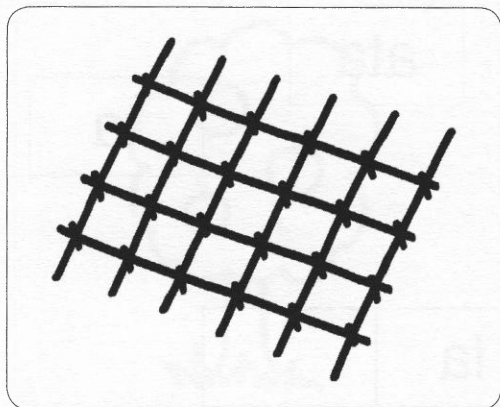

et tre te

re

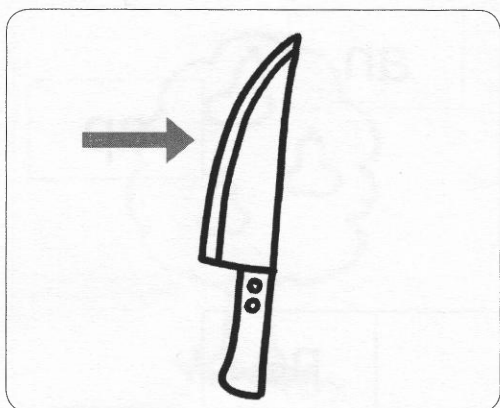

am a ma

la

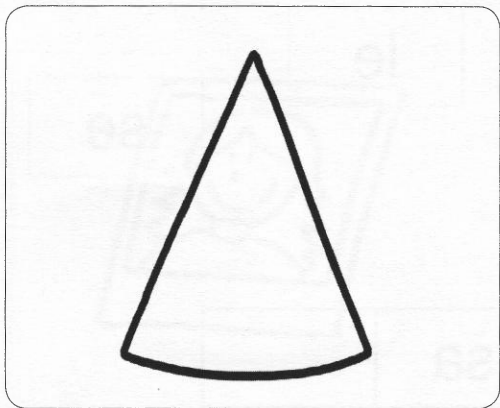

c co on

no

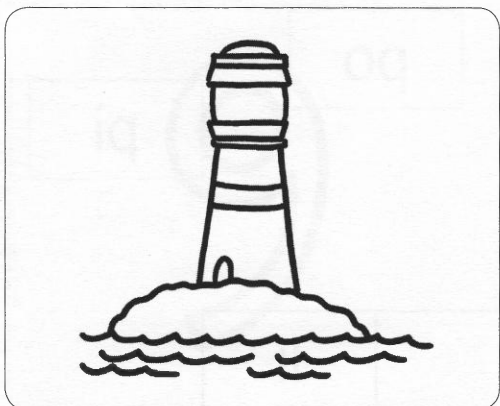

ro fo aro

fa

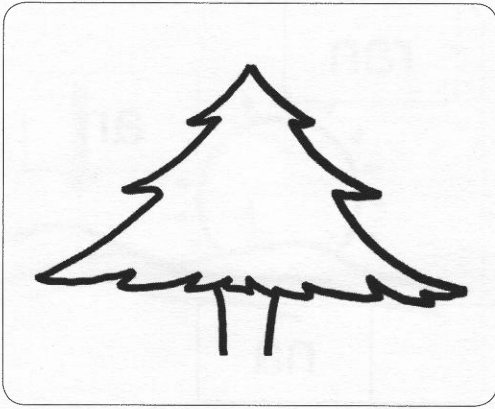

on no io

pi

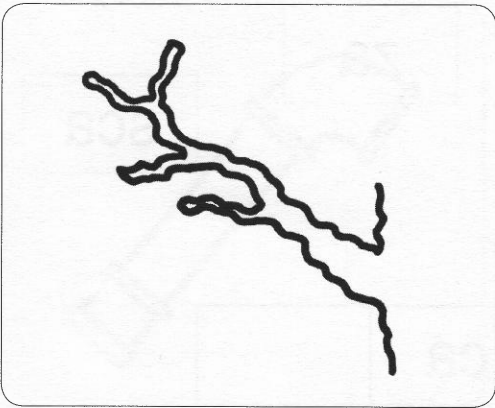

ma amo mo

ra



go co ago

ma

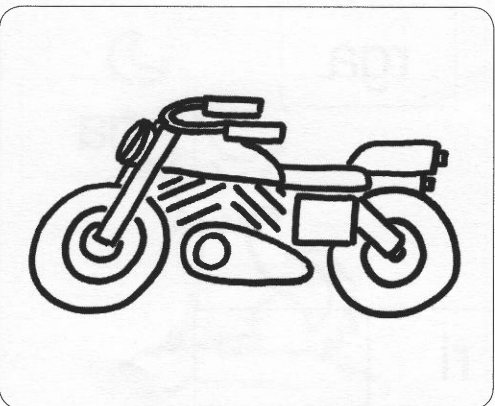

o tom mo

 to

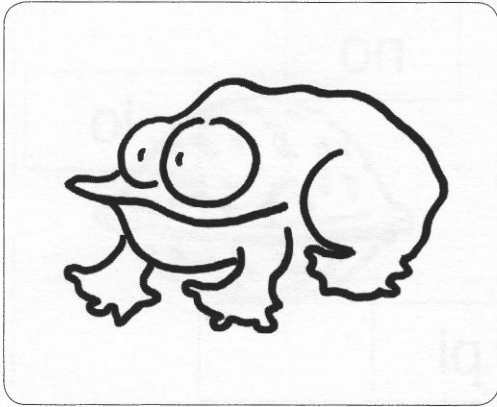

ra

ran

an

na

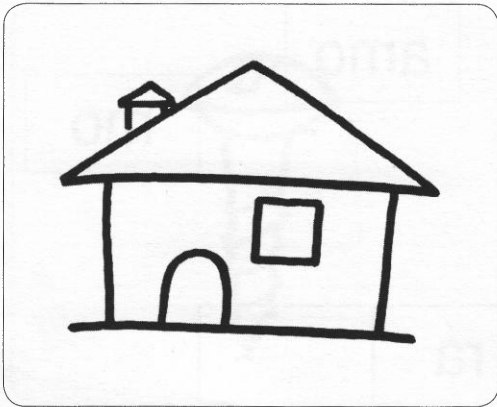

sa

za

sca

ca

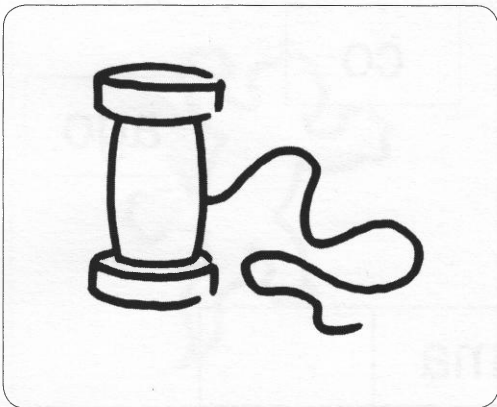

ilo

il

lo

fi

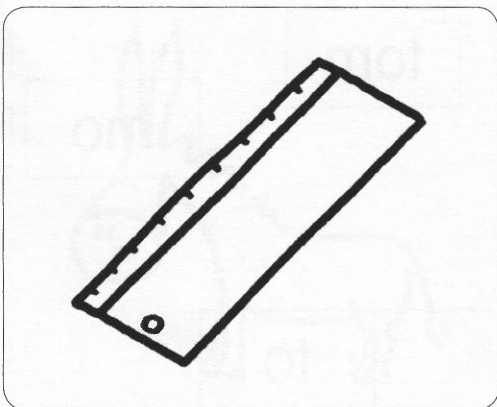

gia

rga

ga

ri

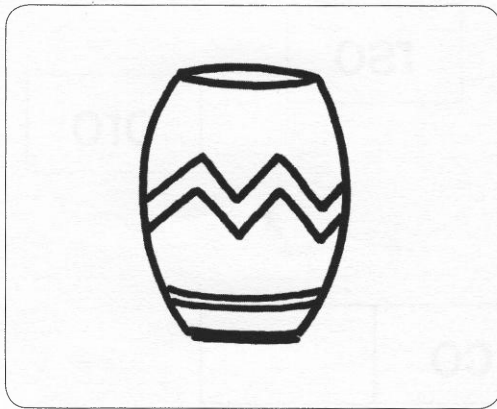

zo fa so

va []

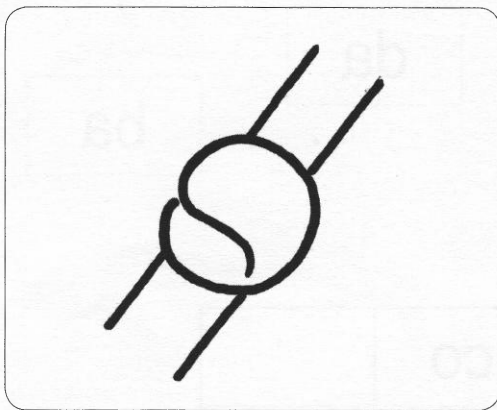

no bo don

[] do

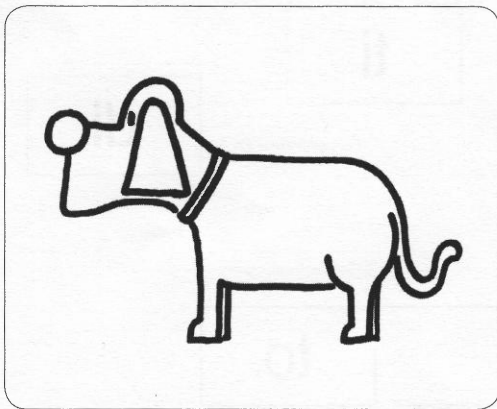

et te ne

ca []

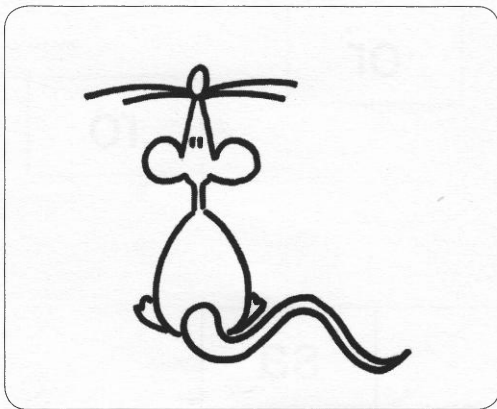

po to pot

[] po

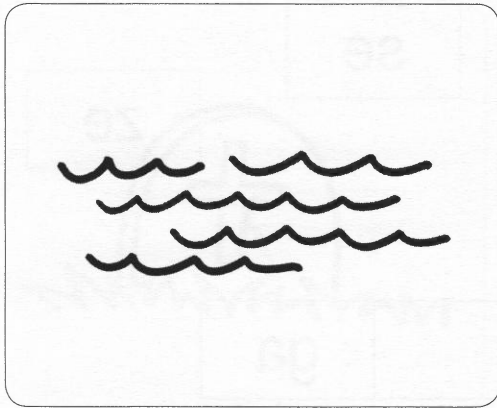

e

ar

re

ma

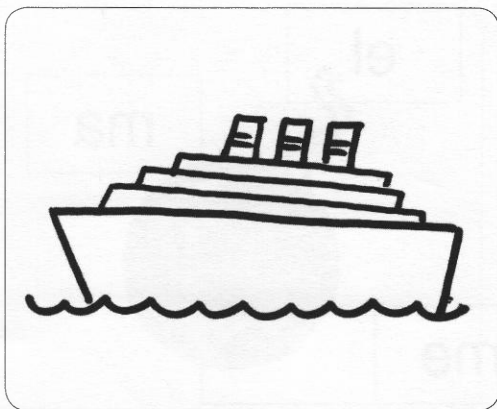

fe

nav

ve

na

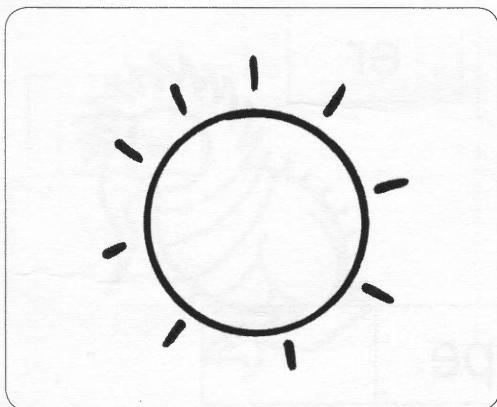

so

sol

se

le

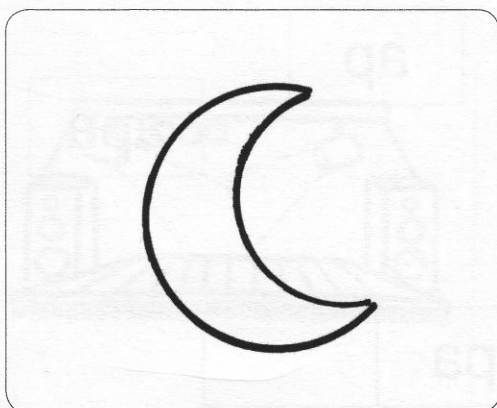

una

na

ua

lu

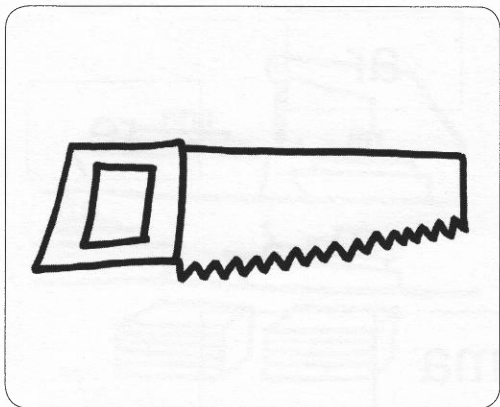

sa

se

ze

ga

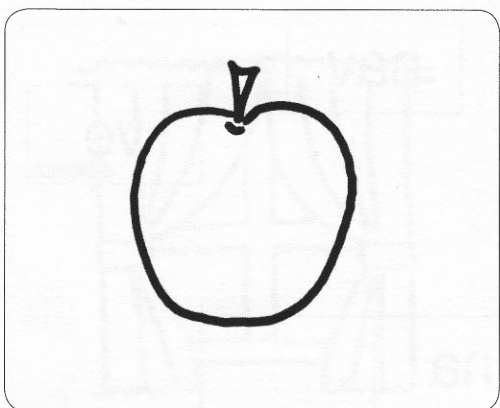

la

el

ma

me

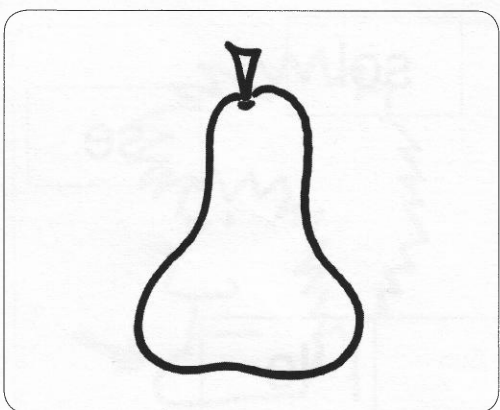

era

er

ra

pe



pa

ap

apa

pa

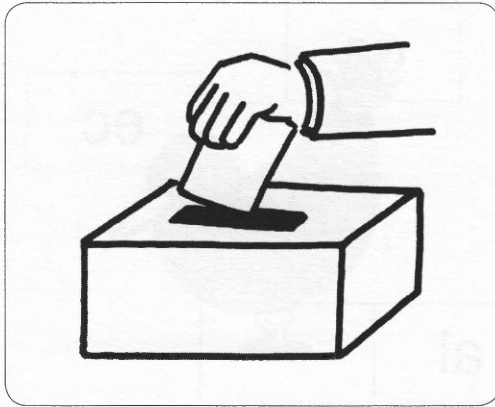

fo

to

vo

to

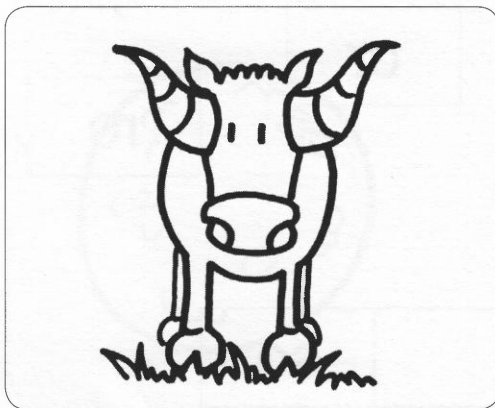

ro

tor

to

ro

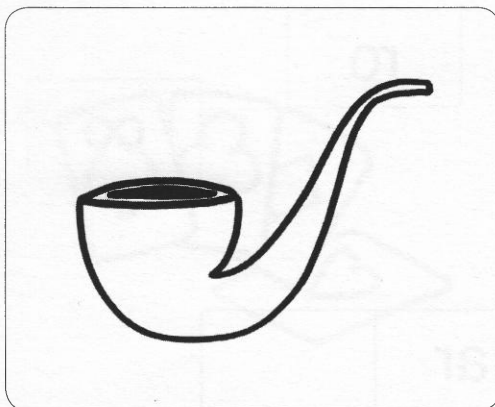

ap

pa

pia

pi

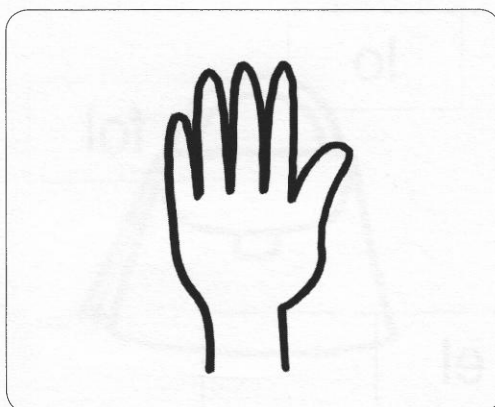

man

ma

nam

no

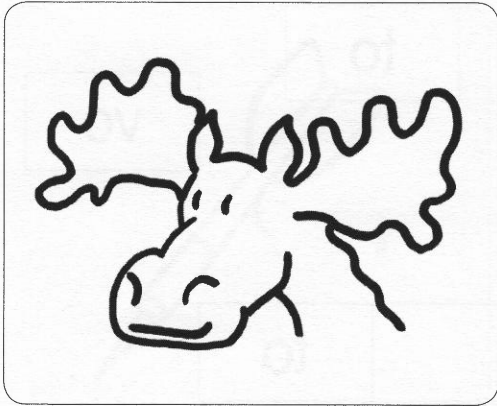

ce ga ec

al

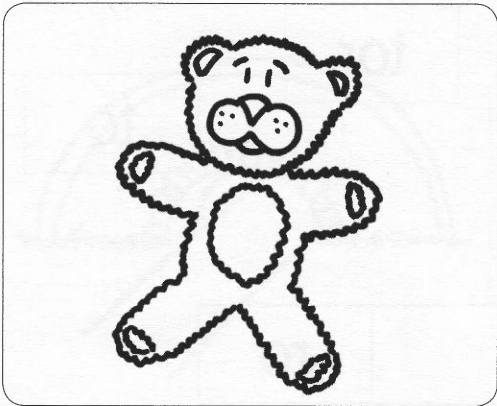

so or ro

 so

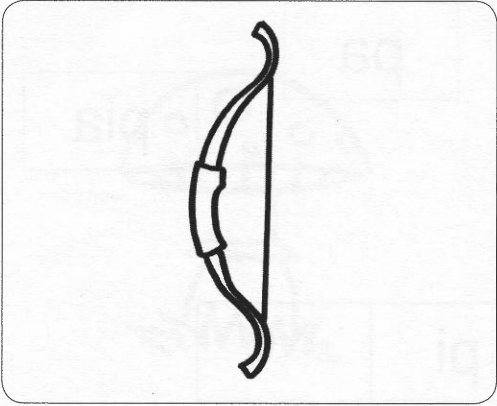

go ro co

ar



fo lo fol

el

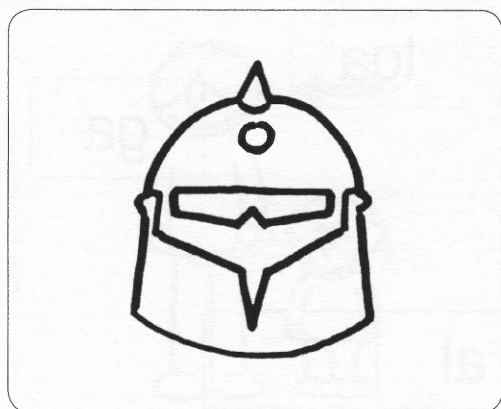

lom lo mo

el

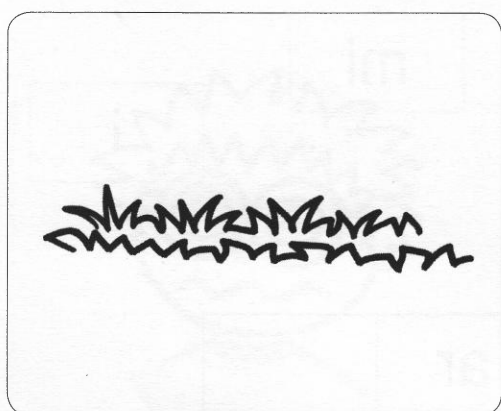

er reb re

ba

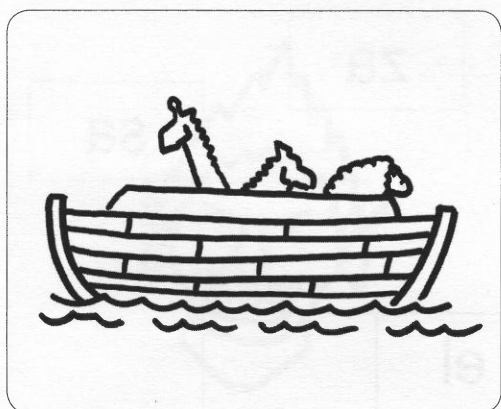

ar bra car

ca

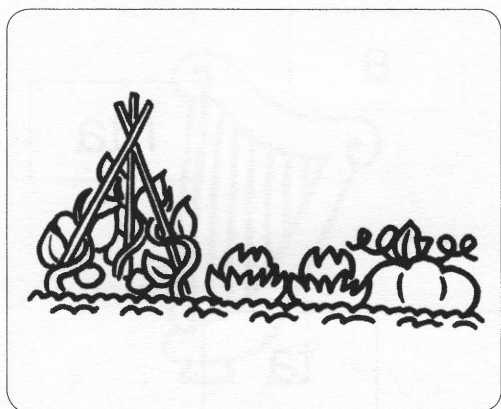

rot or ot

to

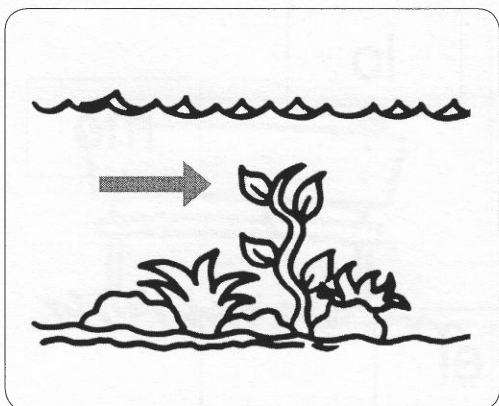

ca lga ga

al

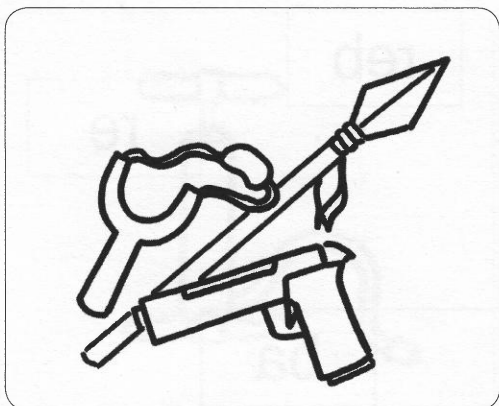

im mi i

ar

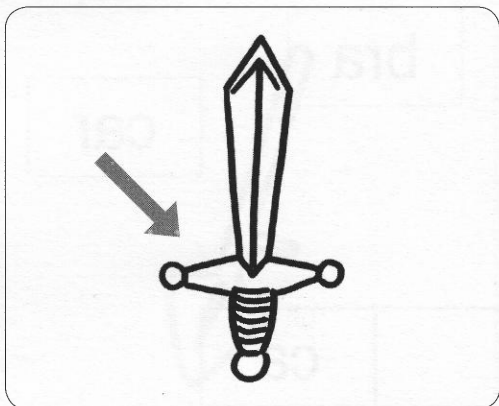

la za sa

el

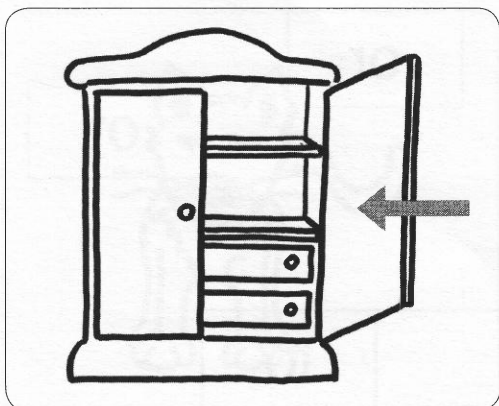

an a nta

ta

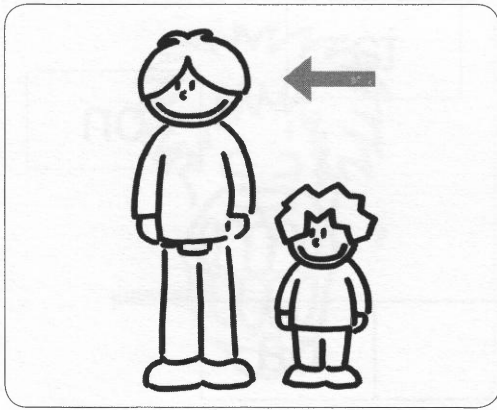

an al lat

to

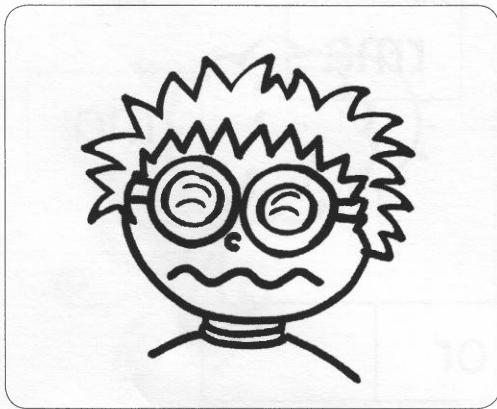

orb do bo

or

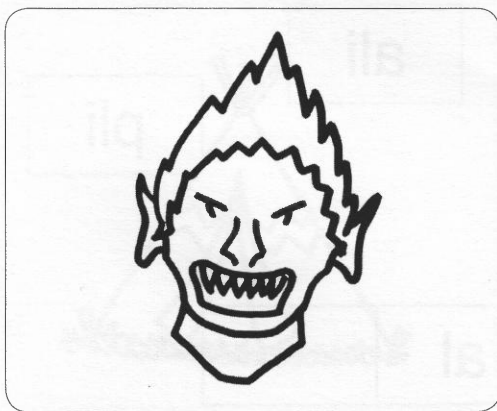

or cor ro

co



pa par ba

ar

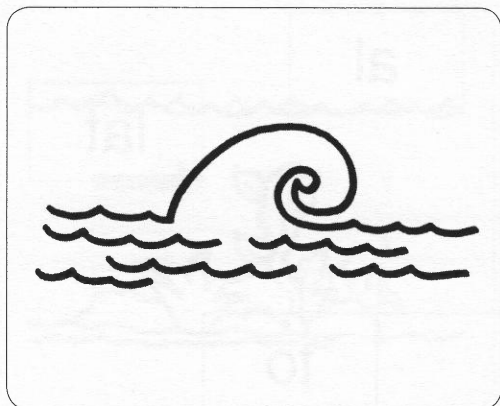

non ta on

al da

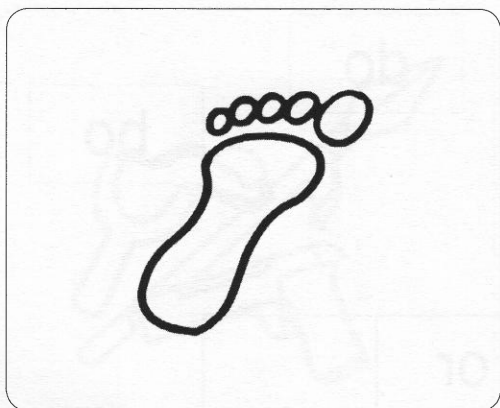

ma rma mo

or

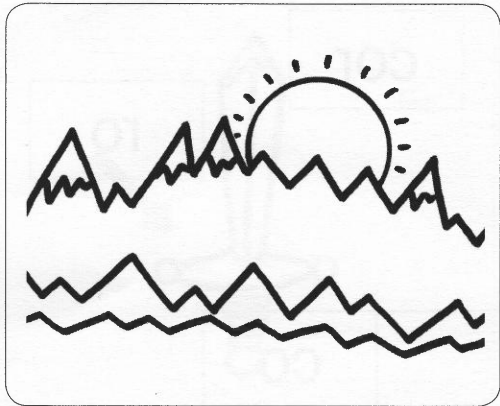

pi ali pli

al

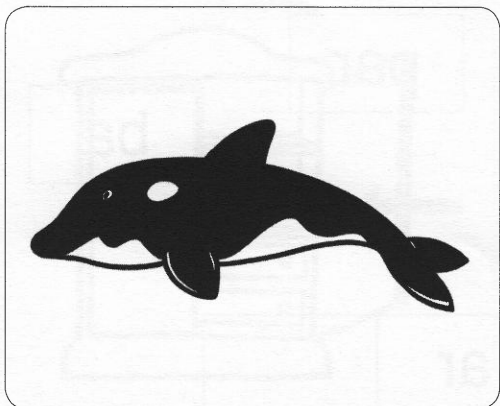

orc cor or

al ca

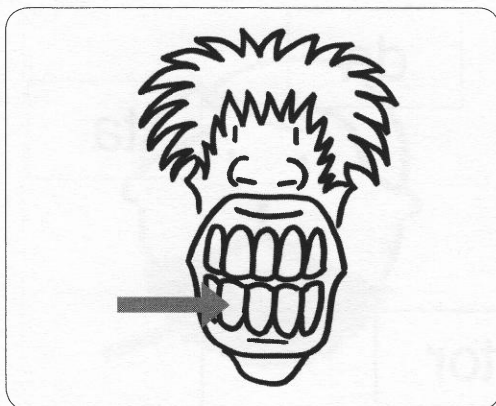

ni ti di

den

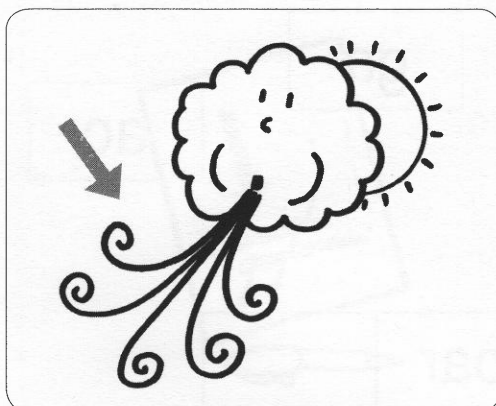

ve ven fe

to

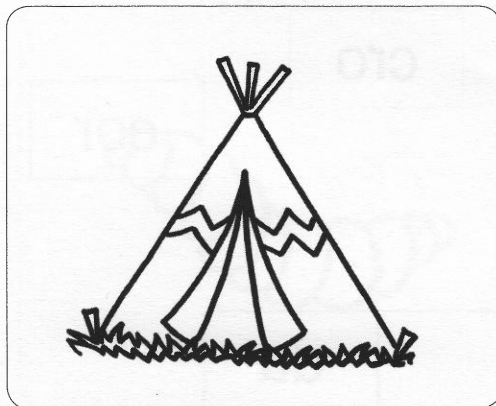

da na ta

ten

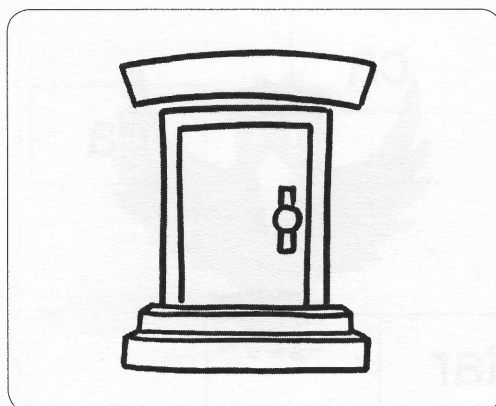

po bo por

ta

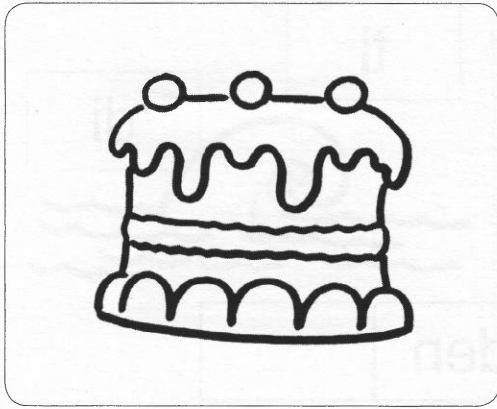

at da ta

tor

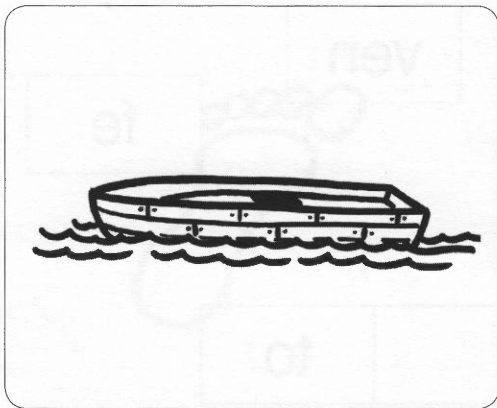

ca ga ac

bar

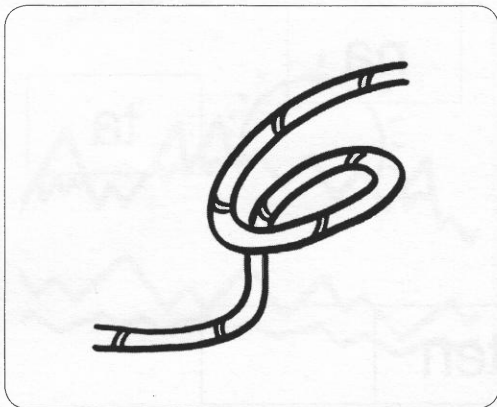

co cro cor

 da

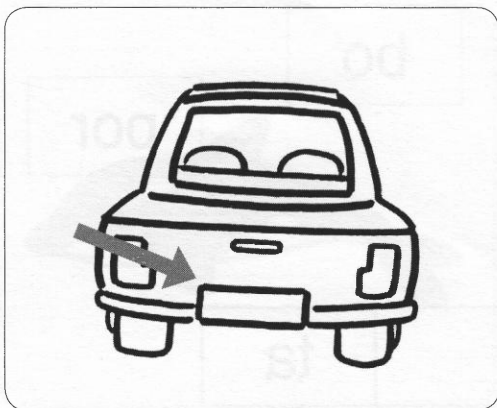

ra ca ga

tar

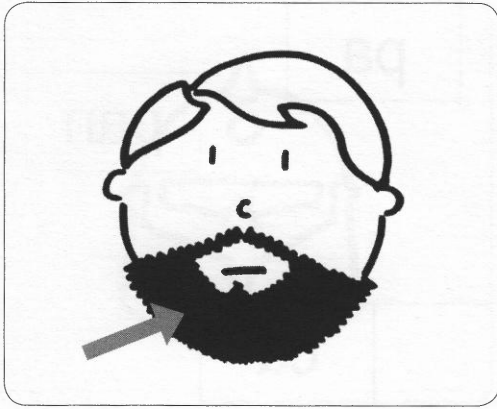

ba

bar

dar

ba

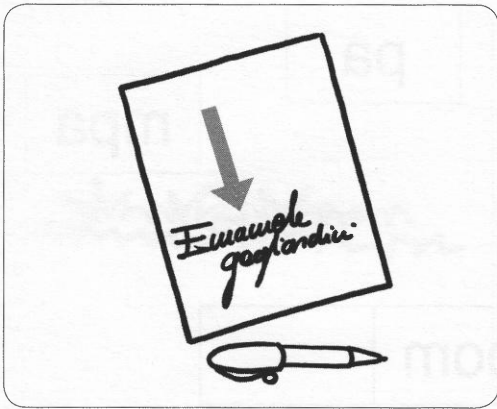

fri

fim

fir

ma

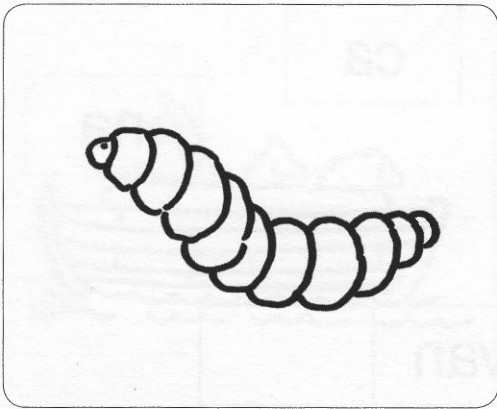

me

re

ne

ver

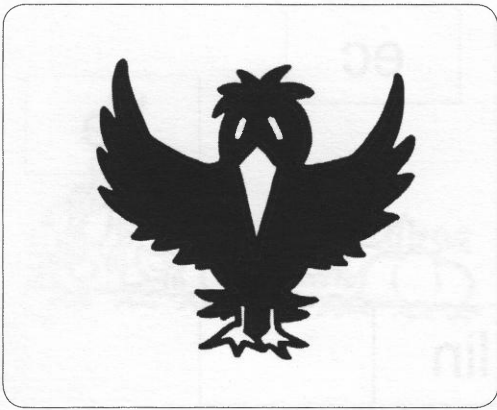

co

cor

cro

vo

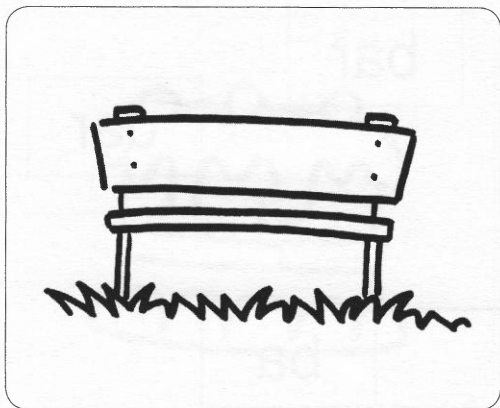

pna

pa

pan

ca

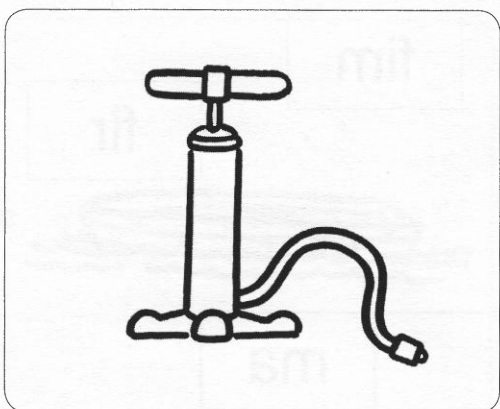

ba

pa

mpa

pom

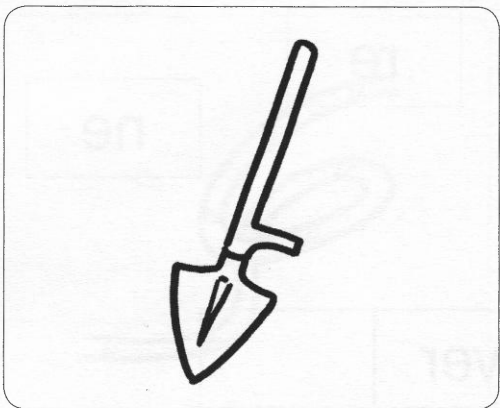

ga

ca

na

van

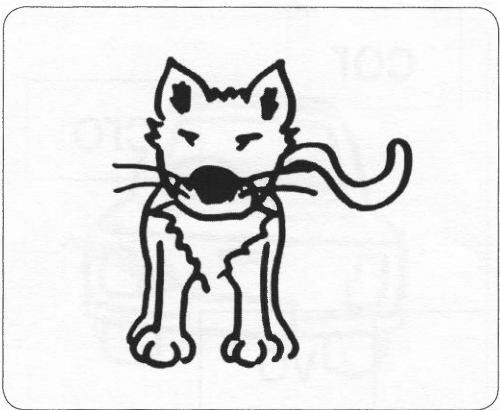

ge

ec

ce

lin

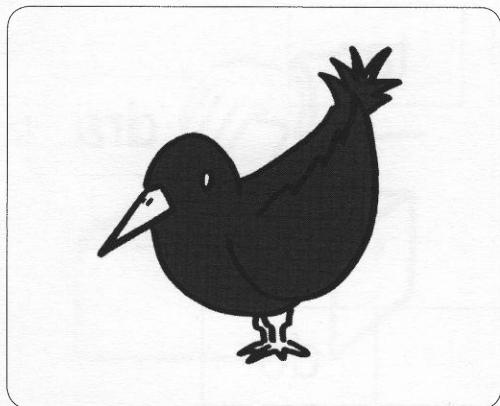

mel

mer

me

lo

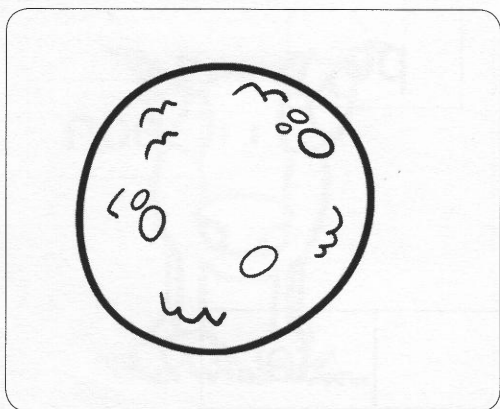

et

te

re

mar

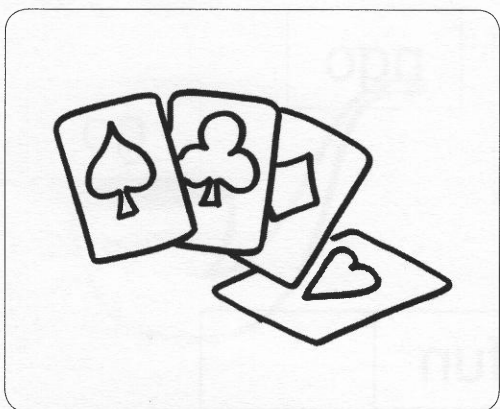

re

rte

te

car



po

bor

bo

sa

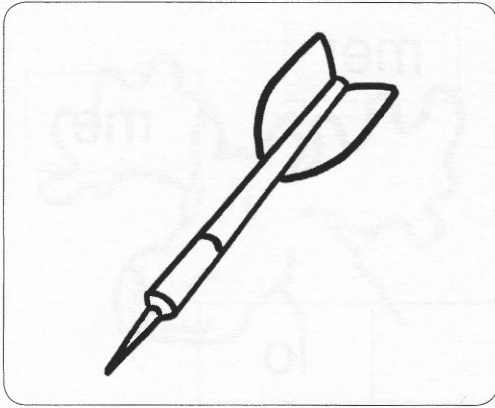

dar

tar

dra

do

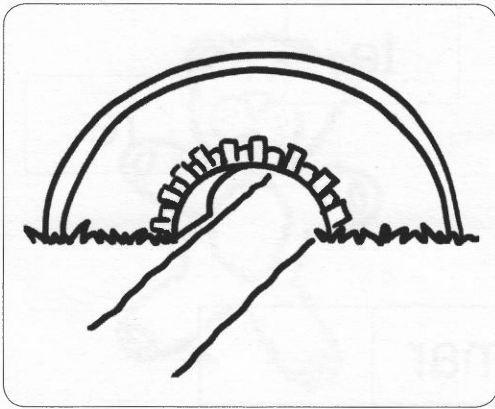

bon

po

pon

te

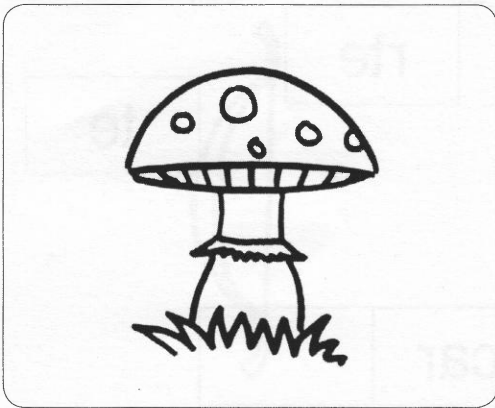

co

ngo

go

fun

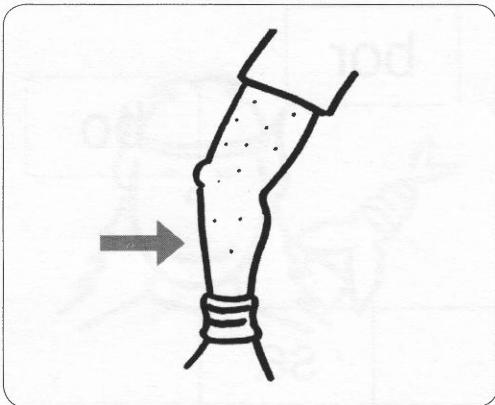

gan

gam

ga

ba

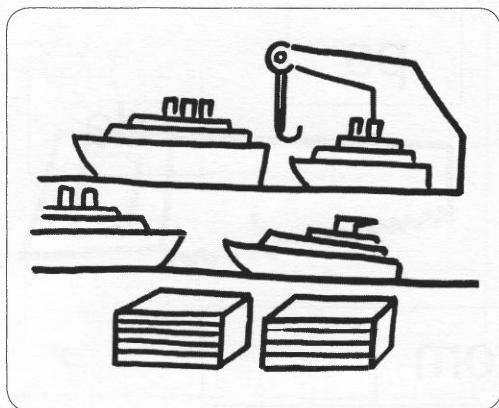

po por pro

to

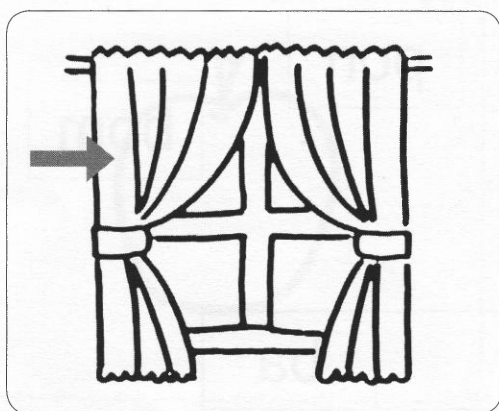

et de te

ten

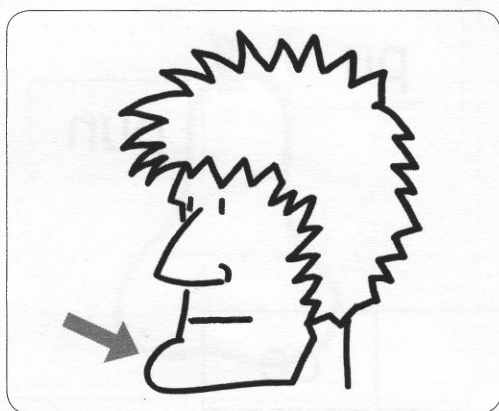

me men nem

to

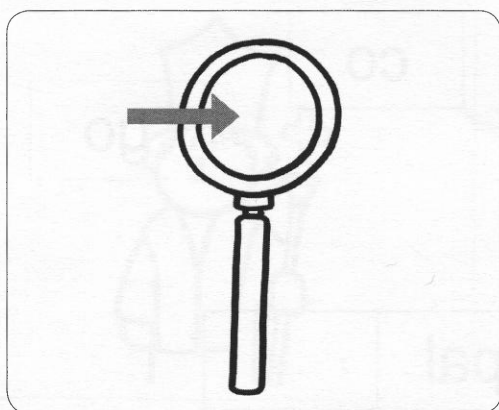

de nte te

len

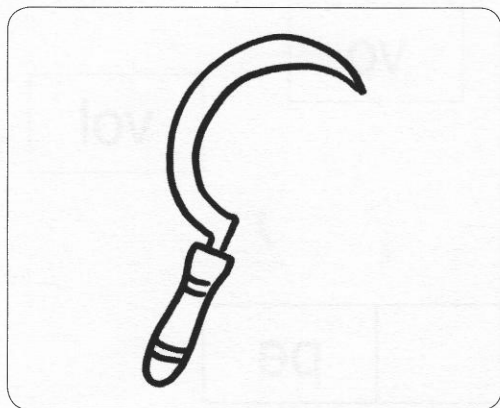

fal val fan

ce

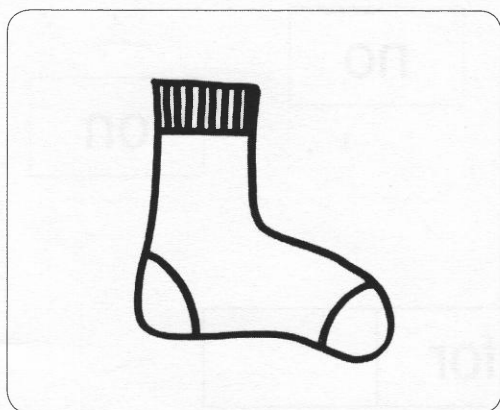

sa za az

cal

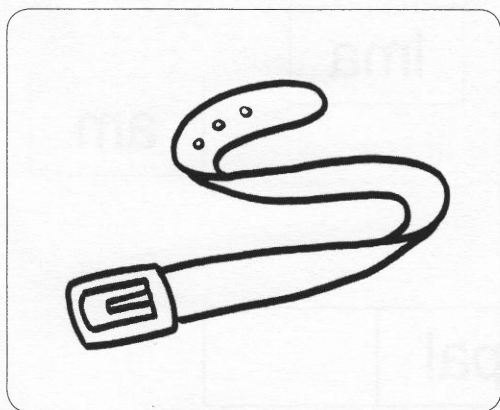

ci gin cin

ta

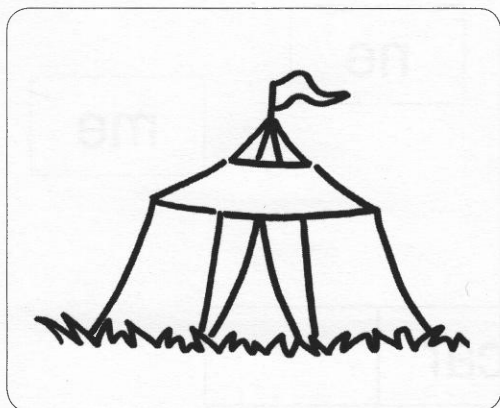

rco co go

cir

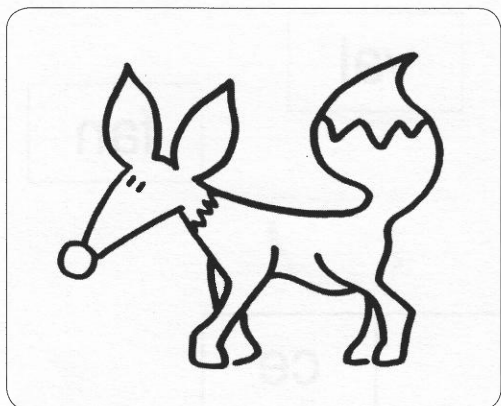

fol vo vol

pe



rno no on

for

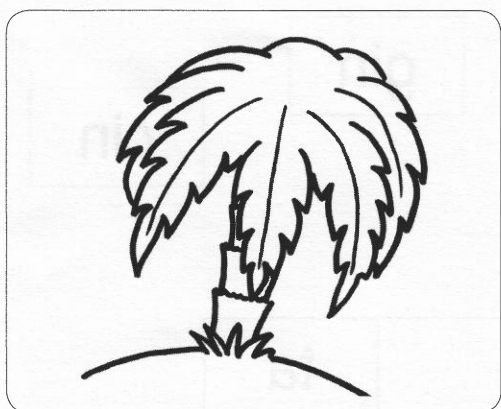

ma lma am

pal

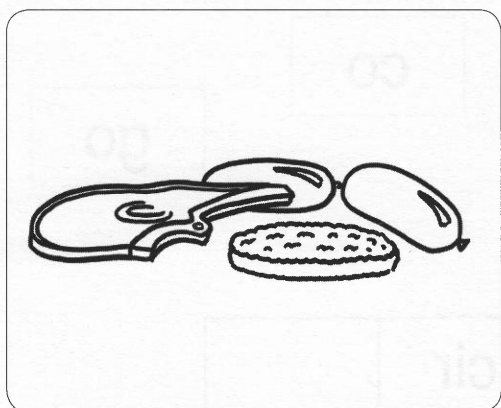

en ne me

car

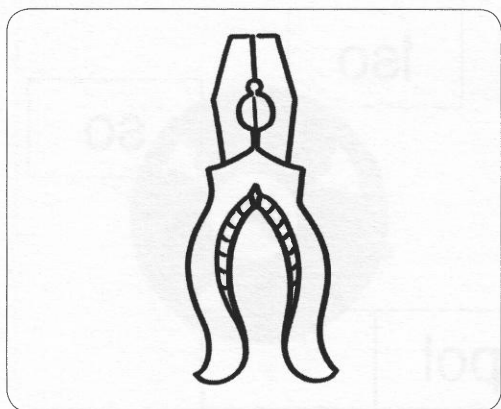

bi

pin

pi

za

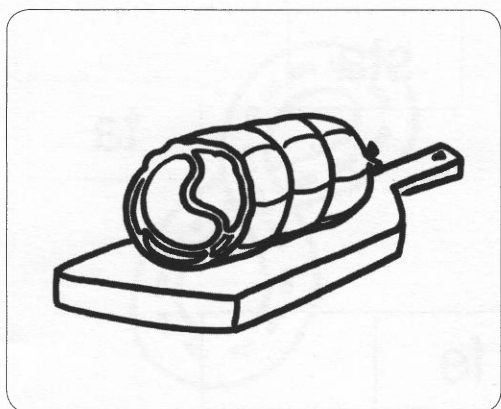

za

sa

nza

lon

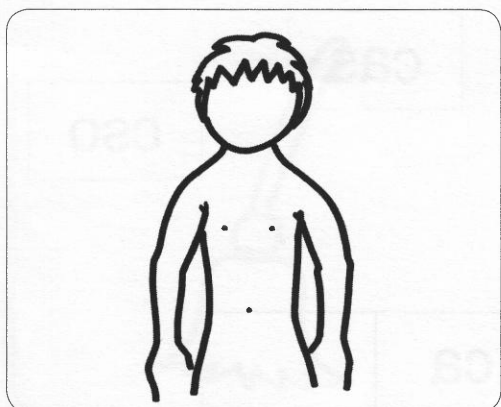

cor

cro

com

po

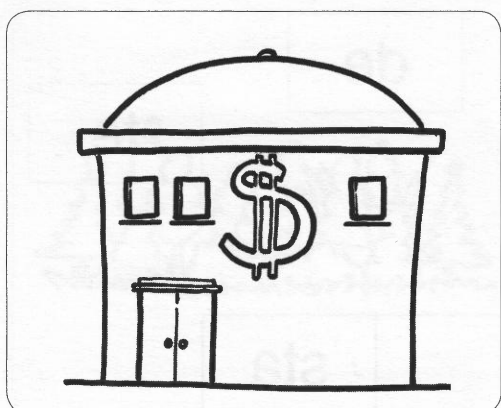

an

bam

ban

ca

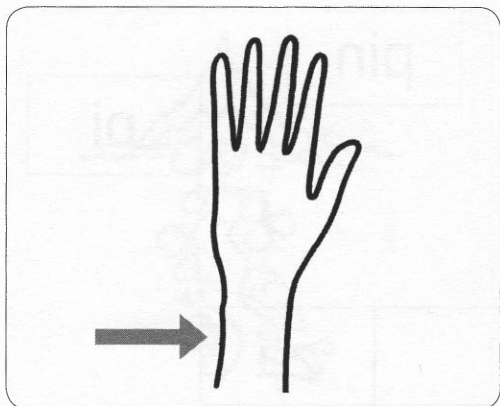

zo iso so

pol

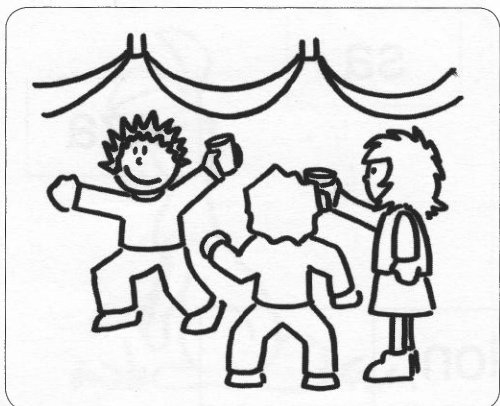

fes sta ta

fe

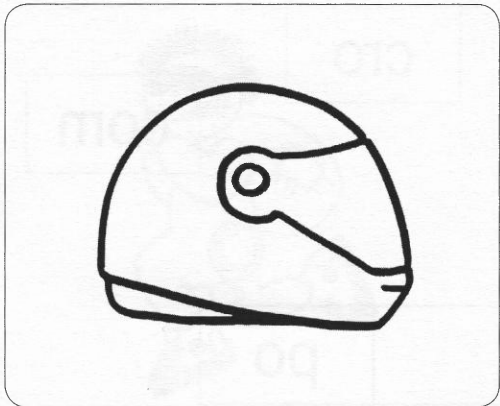

sco cas cso

ca

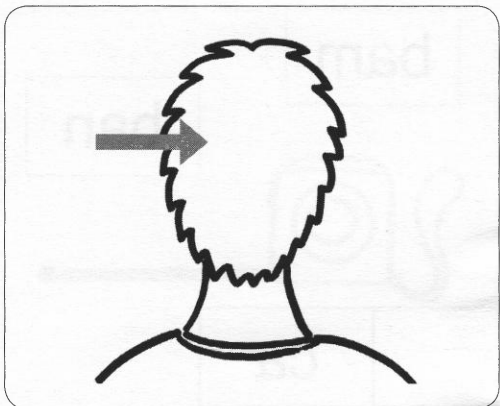

tes de te

sta